

## QTi 4X18 DIM

QUICKTRONIC INTELLIGENT DIM T8 | ECG dimmable 1...10 V for FL 26 mm

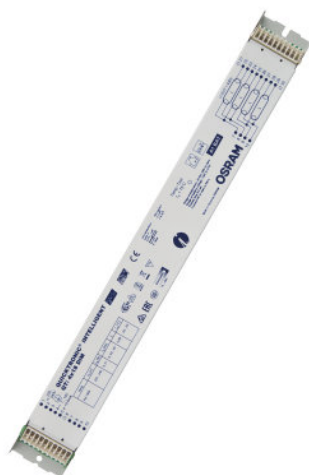

### Product family features

- Control via 1...10 V interface
- Supply voltage: 220...240 V
- Line frequency: 0 Hz | 50 Hz | 60 Hz
- Line voltage: 198...264 V
- Dimming range: 1...100 % luminous flux
- Lamp start: within 0.6 s
- Lifetime: > 100,000 h (for  $T = 65\text{ }^{\circ}\text{C}$  at  $T_c$ )
- Automatic shutdown of defective lamps and at end of life (EoL T.2)
- Energy Efficiency Index EEI: A1 BAT
- Overtemperature protection: Thermal management at high  $t_c$  temperatures
- Safety: to EN 61347-2-3
- Lamp operation: to EN 60929
- RI suppression: to EN 55015:2006+A1:2007+A2:2009/CISPR 15
- Line harmonics according to EN 61000-3-2
- Immunity according to EN 61547

### Product family benefits

- Same luminous flux with direct and alternating current
- Perfect lamp start for applications with motion sensors
- Dimming of amalgam lamps without flickering or reduced lifespan
- Very high efficiency thanks to cut-off technology
- Automatic restart after lamp replacement
- ECGs comply with MINERGIE standard due to very low standby consumption
- Configurable emergency power characteristics
- Control via the 1...10 V interface

### Areas of application

- Suitable for use in emergency lighting systems as per EN 50172/DIN VDE 0108-100
- Installation in emergency lighting systems according to IEC 61347-2-3, appendix J
- Industry
- Open-plan offices, corridors and storage rooms
- Public buildings
- Suitable for luminaires of protection class I

# Product datasheet

## Technical data

### Electrical data

Input voltage AC	198...264 V
Nominal voltage	220...240 V
Mains frequency	50...60 Hz
Input voltage DC	154...276 V
Maximum output power	4 x 18 W
Efficiency in full-load	92 % <sup>1)</sup>
Operating frequency	40...100 kHz
Max. ECG no. on circuit breaker 10 A (B)	12 <sup>2)</sup>
Max. ECG no. on circuit breaker 16 A (B)	19 <sup>2)</sup>
Inrush current	35 A

<sup>1)</sup> at 230 V, 50 Hz

<sup>2)</sup> Type B

### Light technical data

Starting time	0.6 s <sup>1)</sup>
---------------	---------------------

<sup>1)</sup> Optimized preheat start

### Dimensions & weight

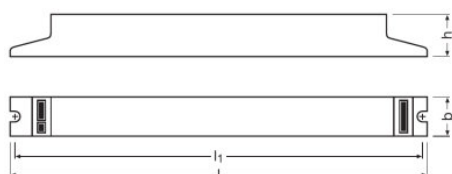

Length	360.0 mm
Width	40.0 mm
Height	21.0 mm
Mounting hole spacing, length	350.0 mm
Product weight	401.00 g
Cable cross-section, output side	0.5...1.5 / 0.5...1.0 mm <sup>2</sup> <sup>1)</sup>
Cable cross-section, input side	0.5...1.5 / 0.5...1.0 mm <sup>2</sup> <sup>1)</sup>

<sup>1)</sup> Solid leads / Flexible

## Temperatures & operating conditions

Ambient temperature range	-20...+50 °C
Permitted rel. humidity during operation	5...85 % <sup>1)</sup>

<sup>1)</sup> Maximum 56 days/year at 85 %

## Lifespan

ECG lifetime	100000 h <sup>1)</sup>
--------------	------------------------

<sup>1)</sup> At  $T_{case} = 65^{\circ}C$  at  $T_c$  point / 10% failure rate

## Additional product data

Suitable for lamp power (4 lamps)	18 W
-----------------------------------	------

## Capabilities

Dimming interface	1...10 V
Dimming range	1...100 % <sup>1)</sup>
Dimmable	Yes
Overheating protection	Power reduction and switch off at $T > 75^{\circ}C$ at the tc point
Suitable for fixtures with prot. class	I
End of lamp life safety shutdown	EOL T.2
Intended for no-load operation	No

<sup>1)</sup> Luminous flux

## Certificates & standards

Approval marks – approval	VDE / VDE-EMC / EAC / CCC
Standards	Acc. to EN 55015; EN 55022/Acc. to EN 61547/Acc. to EN 61000-3-2
EEL – Energy Label	A1 BAT
Protection class	I
Type of protection	IP20

## Logistical data

Commodity code	850410809000
----------------	--------------

## Environmental information

Information according Art. 33 of EU Regulation (EC) 1907/2006 (REACH)	
Date of Declaration	14-04-2022
Primary Article Identifier	4008321070012
Candidate List Substance 1	Lead

## Product datasheet

CAS No. of substance 1	7439-92-1
Safe Use Instruction	The identification of the Candidate List substance is sufficient to allow safe use of the article.
Declaration No. in SCIP database	4aa08c11-d375-4b22-b204-9cc7d8aa7e3a

## Wiring Diagram

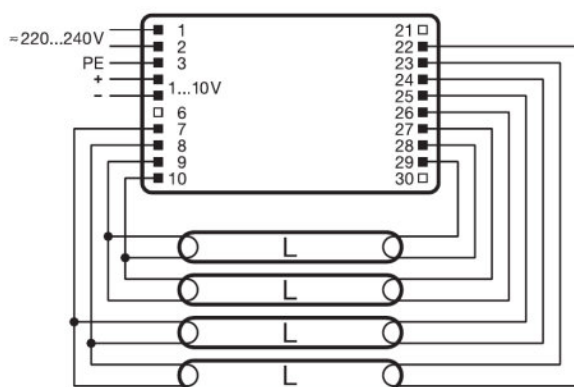



319623\_QTi 4x... DIM











### Additional product information

- In order to achieve good radio interference suppression:1. Keep the cable between ECG and lamp as short as possible.2. The single lamp wires must be routed as close as possible to each other, whereas the lines of the different lamp ends must be routed separately.

### Download Data

File
 Addon Technical Information 502689_Frequent switching Quicktronic
 Addon Technical Information 502785_ECG lifetime - QUICKTRONIC (DALI) DIM
 Product Datasheet 321519_ATI QTi 4x18220-240 DIM (G+GB)

## Product datasheet

	Certificates 334953_EMC-Marks approval
	Certificates 335097_INOTEC
	Certificates QTI DALI VDE 40021252 210920
	Certificates 335169_Manufacturer's declaration &#150; LampECG combinations: Frequent switching
	Certificates 592319_EAC certificate for Quicktronics QT
	Certificates 504208_VDE-EMC-CERTIFICATE QTI DALI DIM
	Operating instructions 592414_EAC QTi T8 DIM
	CAD data 3-dim 321655_QTi 4x18220-240 DIM
	CAD data 3-dim 321656_QTi 4x18220-240 DIM
	CAD data 3-dim 321657_QTi 4x18220-240 DIM
	CAD data PDF 321696_QTi 4x18220-240 DIM

### Ecodesign regulation information:

Separate control gear and light sources must be disposed of at certified disposal companies in accordance with Directive 2012/19/EU (WEEE) in the EU and with Waste Electrical and Electronic Equipment (WEEE) Regulations 2013 in the UK. For this purpose, collection points for recycling centres and take-back systems (CRSO) are available from retailers or private disposal companies, which accept separate control gear and light sources free of charge. In this way, raw materials are conserved and materials are recycled.

### Logistical Data

Product code	Product description	Packaging unit (Pieces/Unit)	Dimensions (length x width x height)	Volume	Gross weight
4008321070012	QTi 4X18 DIM	Shipping carton box 20	384 mm x 90 mm x 210 mm	7.26 dm <sup>3</sup>	8292.00 g

The mentioned product code describes the smallest quantity unit which can be ordered. One shipping unit can contain one or more single products. When placing an order, for the quantity please enter single or multiples of a shipping unit.

## Product datasheet

---

### Disclaimer

Subject to change without notice. Errors and omission excepted. Always make sure to use the most recent release.

## QTi 4X18 DIM

QUICKTRONIC INTELLIGENT DIM T8 | ECG dimmable 1...10 V for FL 26 mm

Product name	Lamp group	Nominal current	Nominal wattage + Power loss	Power factor $\lambda$ [PIM]	Luminous flux at 35 °C	Number of lighting outlets
QTi 4X18 DIM	DULUX F 18 W	0.31 A	69.30 W	0.98	1100 lm	4
	DULUX L 18 W	0.31 A	69.30 W	0.98	1200 lm	4
	L 18 W	0.31 A	69.30 W	0.98	1350 lm	4