

## SIRIUS HRI

High-pressure discharge lamps with reflector



### Areas of application

- Concert lighting
- Club and disco
- Stage and theatre
- Studio, TV and film
- Architecture & Architainment

### Product family benefits

- Lightweight and compact reflector lamps
- Perfectly suited for small and lightweight moving heads
- Optimized burner design allows any burning position
- High luminance through very short arc and high pressure
- Bright light for brilliant light effects
- Long lifetime
- Easy lamp replacement
- Stable light output over the entire lifetime



## Product family datasheet

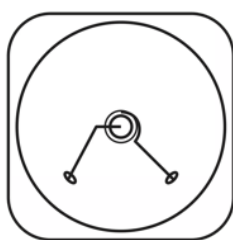
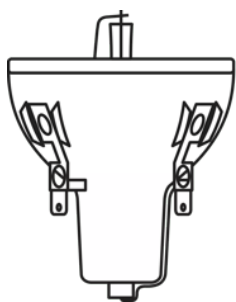

666507\_SIRIUS HRI 100W

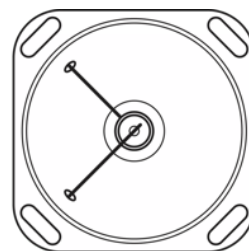
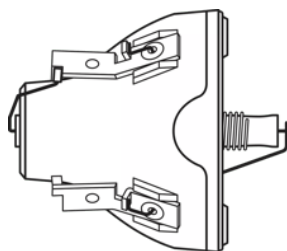

350611\_SIRIUS HRI 132W

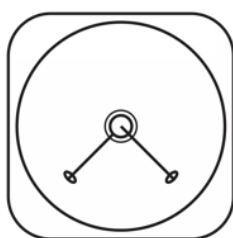
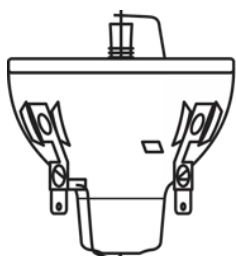

488735\_SIRIUS HRI 132W

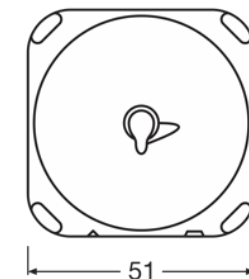
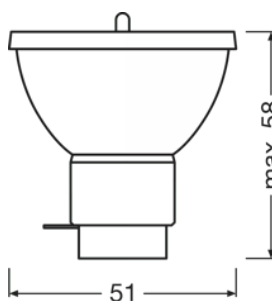

SIRIUS HRI 251W

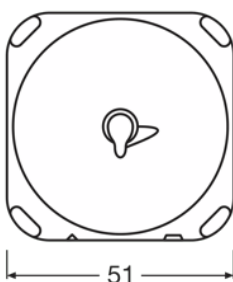
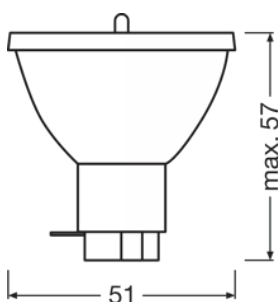

SIRIUS HRI 295 W

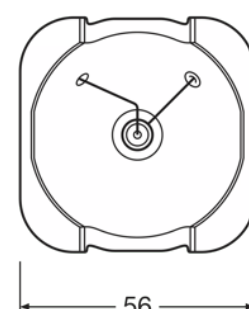
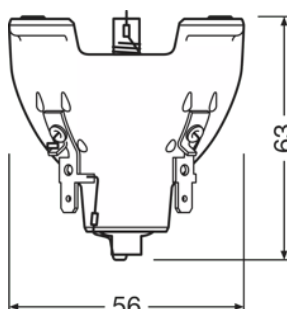

501950\_SIRIUS HRI 330W

## Product family datasheet

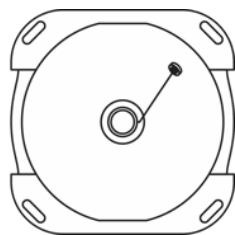
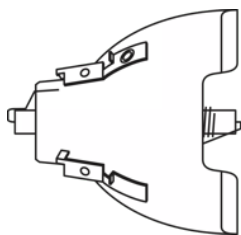

333382\_SIRIUS HRI 330W

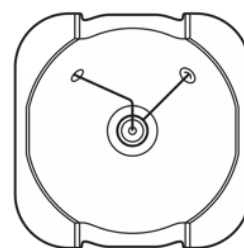
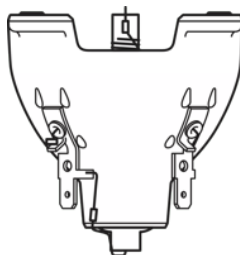

501965\_SIRIUS HRI 330W

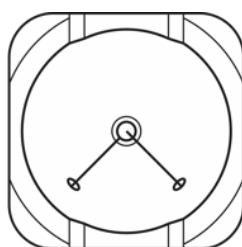
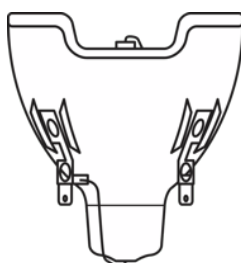

488771\_SIRIUS HRI 330W X8

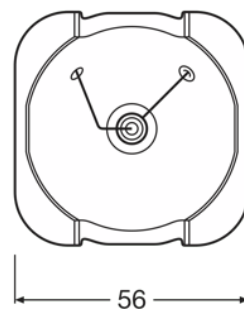
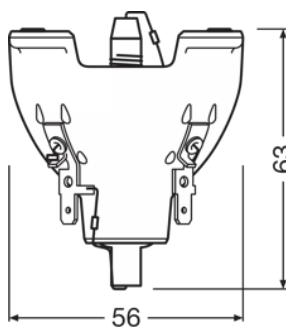

501949\_Sirius HRI 330W XL

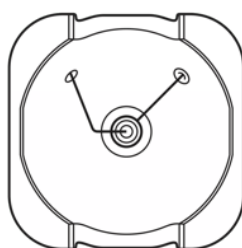
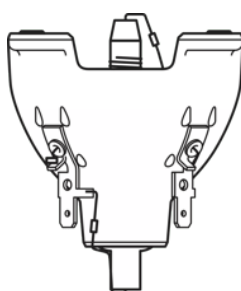

501963\_Sirius HRI 330W XL

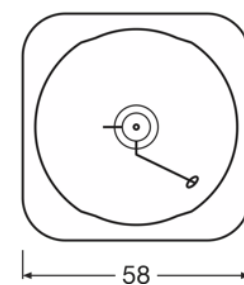
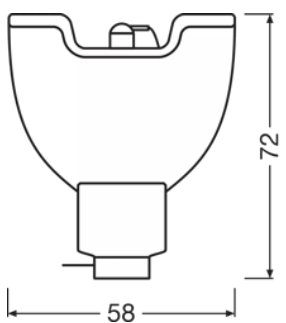

SIRIUS HRI 371W

# Product family datasheet

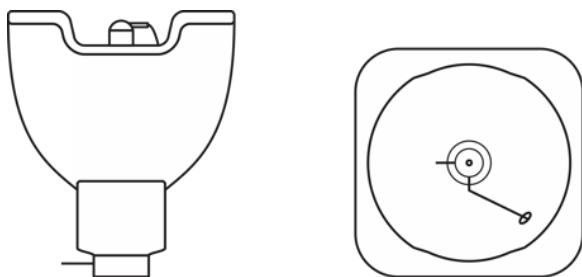

SIRIUS HRI 371W

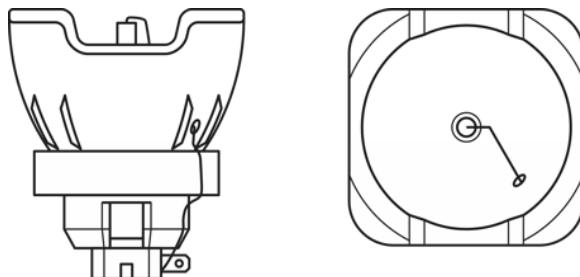

668858\_SIRIUS HRI 440W

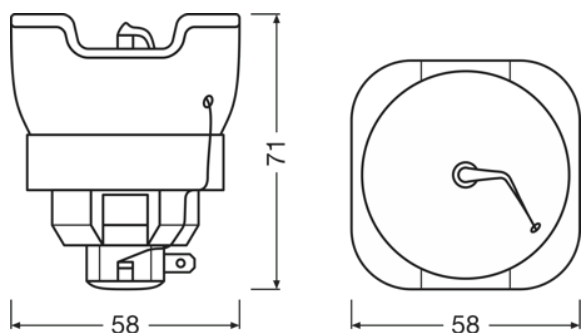

SIRIUS HRI 580 F

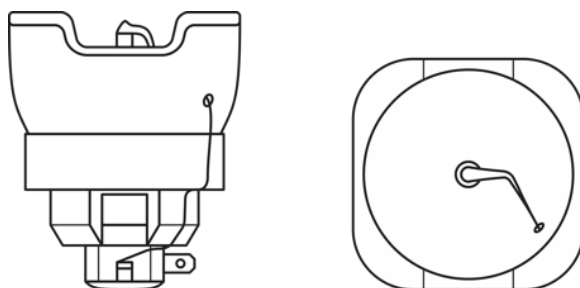

SIRIUS HRI 580 F

## Product family datasheet

### Technical data

Product description	Electrical data		Photometrical data				Light technical data
	Nominal wattage	Nominal current	Nominal luminous flux	Color temperature	Color rendering index Ra	Maximum color temperature	Focal length
SIRIUS HRI 100 W	100.00 W	18 A	3680 lm	9000 K	60	9300 K	30.0 mm
SIRIUS HRI 132 W SC	132.00 W	18 A	5150 lm	9200 K	60	9200 K	37.7 mm
SIRIUS HRI 190 W+	190.00 W	27 A	8100 lm	8200 K	73		
SIRIUS HRI 230 W	230.00 W	33 A	9500 lm	8000 K	75	8000 K	34.5 mm
SIRIUS HRI 231 W	231.00 W	33 A	10800 lm	8000 K	75		
SIRIUS HRI 251 W	250.00 W	35 A	12000 lm	8000 K	77		
SIRIUS HRI 260 W PRO	260.00 W	37 A	13500 lm	7800 K	79		
SIRIUS HRI 280 W	280.00 W	4 A	11500 lm	7800 K	78	7800 K	35.5 mm
SIRIUS HRI 280 W RO	280.00 W	4 A	11500 lm	7800 K	78		
SIRIUS HRI 281 W	281.00 W	4 A	13000 lm	7800 K	78		
SIRIUS HRI 295 W	295.00 W	4.1 A	11300 lm	7800 K	78		
SIRIUS HRI 310 W	310.00 W	45 A	15000 lm	8000 K	84		
SIRIUS HRI 310 W RO	310.00 W	48 A	13000 lm	8500 K	78		
SIRIUS HRI 310 W PRO	310.00 W	5 A	15500 lm	7650 K	85		
SIRIUS HRI 311 W	310.00 W	33 A	14500 lm	8000 K	75		
SIRIUS HRI 330 W	330.00 W	5 A	18000 lm	7400 K	86	7400 K	31.0 mm
SIRIUS HRI 330 W X8	330.00 W	44 A	18000 lm	8000 K	85		
SIRIUS HRI 330 W XL	330.00 W	5 A	16500 lm	7250 K	71		
SIRIUS HRI 371 W	371.00 W	5 A	18300 lm	7650 K	85		
SIRIUS HRI 371 W S	371.00 W	5 A	19800 lm	7650 K	85		
SIRIUS HRI 371 W +	370.00 W	5 A	18300 lm	7650 K	85		
HRI 371 W S +	370.00 W	5 A	19800 lm	7650 K	85		
SIRIUS HRI 381 W S	380.00 W	5 A	20000 lm	7700 K	85		
SIRIUS HRI 380 W Pro	380.00 W	5 A	20000 lm	7700 K	85		
SIRIUS HRI 380 W S PRO	380.00 W	5 A	20000 lm	7700 K	85		
SIRIUS HRI 382 W	382.00 W	54 A	21000 lm	7650 K	85		
SIRIUS HRI 382 W S	380.00 W	54 A	20000 lm	7650 K	85		
SIRIUS HRI 420 W	420.00 W	5 A	22000 lm	7700 K	85		
SIRIUS HRI 420 W S	420.00 W	5 A	21000 lm	7700 K	85		
SIRIUS HRI 440 W	440.00 W	53 A	20000 lm	7000 K	80	7000 K	41.0 mm
SIRIUS HRI 440 W +	440.00 W	53 A	22800 lm	7000 K	80		
SIRIUS HRI 440 W H	440.00 W	53 A	18000 lm	7000 K	75		
SIRIUS HRI 440 W S	440.00 W	44 A	22800 lm	7000 K	80		
SIRIUS HRI 440 W X	440.00 W	53 A	22800 lm	7000 K	80		
SIRIUS HRI 461 W	461.00 W	53 A	24000 lm	7500 K	80		
SIRIUS HRI 461 W S	461.00 W	53 A	24000 lm	7500 K	80		
SIRIUS HRI 462 W	295.00 W	6.20 A	24000 lm	7900 K	85		
SIRIUS HRI 470 W	470.00 W	53 A	20500 lm	7000 K	80		

## Product family datasheet

Product description	Electrical data		Photometrical data				Light technical data
	Nominal wattage	Nominal current	Nominal luminous flux	Color temperature	Color rendering index Ra	Maximum color temperature	Focal length
SIRIUS HRI 470 W S	470.00 W	53 A	21500 lm	7000 K	80		
SIRIUS HRI 470 W RO	470.00 W	5.3 A	19500 lm	7500 K	80		
SIRIUS HRI 470 W XL	470.00 W	53 A	24000 lm	7500 K	80		
SIRIUS HRI 471 W SN	471.00 W	53 A	20000 lm	7500 K	80		
SIRIUS HRI 550 W	550.00 W	6.1 A	28000 lm	7000 K	75		
SIRIUS HRI 550 W XL	550.00 W	6.1 A	28000 lm	7500 K	75		
HRI 580 W F	580.00 W	61 A	29500 lm	7000 K	75		

Product description	Aperture window, maximum	Dimensions & weight		Lifespan	Capabilities	
		Diameter	Length	Lifespan	Burning position	Cooling
SIRIUS HRI 100 W	5x3.8 mm	45.0 mm	53.0 mm	6000 h	Any	Forced
SIRIUS HRI 132 W SC	5x3.8 mm	46.0 mm	max. 44 mm	6000 h	Any	Forced
SIRIUS HRI 190 W+		51.0 mm	54.5 mm	3000 h		
SIRIUS HRI 230 W	5x3.8 mm	51.0 mm	54.5 mm	2500 h	Any	Forced
SIRIUS HRI 231 W		51.0 mm	50.0 mm	2000 h	Any	
SIRIUS HRI 251 W		51.0 mm	61.0 mm	3000 h		
SIRIUS HRI 260 W PRO		51.0 mm	50.0 mm	6000 h		
SIRIUS HRI 280 W	5x3.8 mm	51.0 mm	54.5 mm	2000 h	Any	Forced
SIRIUS HRI 280 W RO		51.0 mm	54.5 mm	2000 h	Any	
SIRIUS HRI 281 W		51.0 mm	50.0 mm	2000 h	Any	
SIRIUS HRI 295 W		51.0 mm	53.5 mm	2500 h		
SIRIUS HRI 310 W		51.0 mm	53.5 mm	2500 h		
SIRIUS HRI 310 W RO		60.0 mm	67.0 mm	4000 h	Any	
SIRIUS HRI 310 W PRO		58.0 mm	72.0 mm	6000 h		
SIRIUS HRI 311 W		51.0 mm	50.0 mm	1500 h		
SIRIUS HRI 330 W	8.0 mm	56.0 mm	63.0 mm	1500 h	Any	Forced
SIRIUS HRI 330 W X8		58.0 mm	66.0 mm	1500 h	Any	
SIRIUS HRI 330 W XL		56.0 mm	63.0 mm	1500 h	Any	
SIRIUS HRI 371 W		58.0 mm	72.0 mm	1500 h	Any	
SIRIUS HRI 371 W S		58.0 mm	72.0 mm	1500 h	Any	
SIRIUS HRI 371 W +		58.0 mm	72.0 mm	3000 h		
HRI 371 W S +		58.0 mm	72.0 mm	3000 h		
SIRIUS HRI 381 W S		58.0 mm	72.0 mm	2500 h		
SIRIUS HRI 380 W Pro		58.0 mm	72.0 mm	2500 h		
SIRIUS HRI 380 W S PRO		58.0 mm	72.0 mm	6000 h		
SIRIUS HRI 382 W		58.0 mm	72.0 mm	2500 h		
SIRIUS HRI 382 W S		58.0 mm	72.0 mm	2500 h		
SIRIUS HRI 420 W		58.0 mm	72.0 mm	2500 h		
SIRIUS HRI 420 W S		58.0 mm	72.0 mm	2500 h		
SIRIUS HRI 440 W	8.0 mm	58.0 mm	71.0 mm	1500 h	Any	Forced

## Product family datasheet

Product description	Aperture window, maximum	Dimensions & weight		Lifespan	Capabilities	
		Diameter	Length	Lifespan	Burning position	Cooling
SIRIUS HRI 440 W +		58.0 mm	71.0 mm	1500 h		
SIRIUS HRI 440 W H		65.0 mm	60.0 mm	1500 h	Any	
SIRIUS HRI 440 W S		11.8 mm	71.0 mm	1500 h	Any	
SIRIUS HRI 440 W X		58.0 mm	71.0 mm	1500 h		
SIRIUS HRI 461 W		60.0 mm	67.0 mm	1500 h	Any	
SIRIUS HRI 461 W S		60.0 mm	67.0 mm	1500 h	Any	
SIRIUS HRI 462 W		58.0 mm	72.0 mm	2000 h		
SIRIUS HRI 470 W		58.0 mm	71.0 mm	1500 h	Any	
SIRIUS HRI 470 W S		58.0 mm	71.0 mm	1500 h	Any	
SIRIUS HRI 470 W RO		60.0 mm	67.0 mm	1500 h	Any	
SIRIUS HRI 470 W XL		60.0 mm	67.0 mm	1500 h	Any	
SIRIUS HRI 471 W SN		60.0 mm	67.0 mm	1500 h	Any	
SIRIUS HRI 550 W		60.0 mm	67.0 mm	1500 h		
SIRIUS HRI 550 W XL		60.0 mm	67.0 mm	1500 h		
HRI 580 W F		65.0 mm	65.0 mm	1000 h		

Product description	Certificates & standards	Environmental information Information according Art. 33 of EU Regulation (EC) 1907/2006 (REACH)		
	EEI – Energy Label	Date of Declaration	Primary Article Identifier	Candidate List Substance 1
SIRIUS HRI 100 W	B	06-03-2024	4052899321656   4052899329119	No declarable substances contained
SIRIUS HRI 132 W SC	A	06-03-2024	4052899011335   4052899028708   4052899197404	No declarable substances contained
SIRIUS HRI 190 W+		07-03-2024	4008321866592   4052899475397	No declarable substances contained
SIRIUS HRI 230 W	A	05-03-2024	4008321678225   4008321810311	No declarable substances contained
SIRIUS HRI 231 W	A	06-03-2024	4052899512634   4052899553521   4062172041430   4062172128681   4062172212311	No declarable substances contained
SIRIUS HRI 251 W		07-03-2024	4062172212458   4062172212434	No declarable substances contained
SIRIUS HRI 260 W PRO		07-03-2024	4062172118941   4062172118927	No declarable substances contained
SIRIUS HRI 280 W	A	05-03-2024	4008321734303   4008321810342	No declarable substances contained
SIRIUS HRI 280 W RO	A	06-03-2024	4052899082151   4052899110397	No declarable substances contained
SIRIUS HRI 281 W	A	06-03-2024	4052899553552   4062172041454   4062172128704	No declarable substances contained
SIRIUS HRI 295 W		26-10-2023	4062172283328   4062172283304	No declarable substances contained

## Product family datasheet

Product description	Certificates & standards	Environmental information Information according Art. 33 of EU Regulation (EC) 1907/2006 (REACH)		
	EEI – Energy Label	Date of Declaration	Primary Article Identifier	Candidate List Substance 1
SIRIUS HRI 310 W		07-12-2023	4062172202169   4062172202183	
SIRIUS HRI 310 W RO		07-12-2023	4062172013536   4062172063449   4062172140867   4062172140843	No declarable substances contained
SIRIUS HRI 310 W PRO		07-03-2024	4062172085304   4062172169424   4062172169455	No declarable substances contained
SIRIUS HRI 311 W		07-03-2024	4062172169363	
SIRIUS HRI 330 W		05-03-2024	4008321754448   4008321810373	No declarable substances contained
SIRIUS HRI 330 W X8	A	06-03-2024	4052899140295   4052899140325   4052899224346	No declarable substances contained
SIRIUS HRI 330 W XL		06-03-2024	4008321848765   4052899195431	No declarable substances contained
SIRIUS HRI 371 W		06-03-2024	4062172057004   4062172056984   4052899558649   4052899558670	No declarable substances contained
SIRIUS HRI 371 W S		06-03-2024	4062172056953   4062172056939   4052899558618	No declarable substances contained
SIRIUS HRI 371 W +		07-03-2024	4062172110341   4062172110327	No declarable substances contained
HRI 371 W S +		15-03-2024	4062172110396   4062172110372   4062172390729	No declarable substances contained
SIRIUS HRI 381 W S		22-12-2023	4062172226240   4062172226226	No declarable substances contained
SIRIUS HRI 380 W Pro		07-03-2024	4062172168625   4062172168601	No declarable substances contained
SIRIUS HRI 380 W S PRO		22-12-2023	4062172168335   4062172168311	No declarable substances contained
SIRIUS HRI 382 W		07-12-2023	4062172047135   4062172326131	No declarable substances contained
SIRIUS HRI 382 W S		07-12-2023	4062172033541   4062172326100	No declarable substances contained
SIRIUS HRI 420 W		07-03-2024	4062172192750   4062172192736	No declarable substances contained
SIRIUS HRI 420 W S		26-10-2023	4062172192705   4062172192682   4062172392938   4062172392891   4062172393225   4062172393201	No declarable substances contained



## Product family datasheet

Product description	Certificates & standards	Environmental information Information according Art. 33 of EU Regulation (EC) 1907/2006 (REACH)		
	EEI – Energy Label	Date of Declaration	Primary Article Identifier	Candidate List Substance 1
SIRIUS HRI 440 W	A	06-03-2024	4052899222212   4052899259096   4052899553644   4052899570566   4052899587892	No declarable substances contained
SIRIUS HRI 440 W +		22-12-2023	4062172047333   4062172348874	No declarable substances contained
SIRIUS HRI 440 W H		06-03-2024	4052899509528   4052899576735	No declarable substances contained
SIRIUS HRI 440 W S	A	06-03-2024	4052899276543   4052899329140	No declarable substances contained
SIRIUS HRI 440 W X		07-03-2024	4062172017442	No declarable substances contained
SIRIUS HRI 461 W		06-03-2024	4052899532274   4052899553613	No declarable substances contained
SIRIUS HRI 461 W S		06-03-2024	4052899532298   4052899553583	No declarable substances contained
SIRIUS HRI 462 W		26-10-2023	4062172302128   4062172302104	No declarable substances contained
SIRIUS HRI 470 W		22-12-2023	4052899580961   4062172169332	No declarable substances contained
SIRIUS HRI 470 W S		06-03-2024	4052899580985   4062172169301	No declarable substances contained
SIRIUS HRI 470 W RO	A	17-05-2024	4052899476998   4052899477018   4062172392556	No declarable substances contained
SIRIUS HRI 470 W XL		06-03-2024	4052899581166   4062172017473   4062172168281	No declarable substances contained
SIRIUS HRI 471 W SN		06-03-2024	4052899581005   4062172040358	No declarable substances contained
SIRIUS HRI 550 W		06-03-2024	4062172008761   4062172078122	No declarable substances contained
SIRIUS HRI 550 W XL		27-10-2023	4062172008785   4062172168236   4062172168212	No declarable substances contained
HRI 580 W F		22-12-2023	4062172085267	No declarable substances contained

Product description	Declaration No. in SCIP database
SIRIUS HRI 100 W	No declarable substances contained
SIRIUS HRI 132 W SC	In work
SIRIUS HRI 190 W+	In work
SIRIUS HRI 230 W	In work
SIRIUS HRI 231 W	In work

## Product family datasheet

Product description	Declaration No. in SCIP database
SIRIUS HRI 251 W	No declarable substances contained
SIRIUS HRI 260 W PRO	In work
SIRIUS HRI 280 W	In work
SIRIUS HRI 280 W RO	In work
SIRIUS HRI 281 W	In work
SIRIUS HRI 295 W	No declarable substances contained
SIRIUS HRI 310 W	In work
SIRIUS HRI 310 W RO	In work
SIRIUS HRI 310 W PRO	In work
SIRIUS HRI 311 W	In work
SIRIUS HRI 330 W	In work
SIRIUS HRI 330 W X8	In work
SIRIUS HRI 330 W XL	In work
SIRIUS HRI 371 W	In work
SIRIUS HRI 371 W S	In work
SIRIUS HRI 371 W +	In work
HRI 371 W S +	In work
SIRIUS HRI 381 W S	In work
SIRIUS HRI 380 W Pro	In work
SIRIUS HRI 380 W S PRO	No declarable substances contained
SIRIUS HRI 382 W	In work
SIRIUS HRI 382 W S	No declarable substances contained
SIRIUS HRI 420 W	In work
SIRIUS HRI 420 W S	In work
SIRIUS HRI 440 W	In work
SIRIUS HRI 440 W +	No declarable substances contained
SIRIUS HRI 440 W H	In work
SIRIUS HRI 440 W S	In work
SIRIUS HRI 440 W X	No declarable substances contained
SIRIUS HRI 461 W	No declarable substances contained
SIRIUS HRI 461 W S	No declarable substances contained
SIRIUS HRI 462 W	No declarable substances contained
SIRIUS HRI 470 W	No declarable substances contained
SIRIUS HRI 470 W S	In work
SIRIUS HRI 470 W RO	In work
SIRIUS HRI 470 W XL	In work

## Product family datasheet

<b>Product description</b>	<b>Declaration No. in SCIP database</b>
SIRIUS HRI 471 W SN	In work
SIRIUS HRI 550 W	In work
SIRIUS HRI 550 W XL	In work
HRI 580 W F	No declarable substances contained

## Product family datasheet

---

### Safety advice

Because of their high luminance, UV radiation and high internal pressure during operation, SIRIUS HRI lamps may only be operated in enclosed lamp casings specially constructed for the purpose. Appropriate filters must ensure that UV radiation is reduced to an acceptable level. Mercury is released if the lamp breaks. Special safety precautions must be taken. Information on safety and handling is available on request or can be found in the leaflet included with the lamp or in the operating instructions.

---

### Application advice

For more detailed application information and graphics please see product datasheet.

---

### Disclaimer

Subject to change without notice. Errors and omission excepted. Always make sure to use the most recent release.